

Product ID: Vault Cupboard Acc.

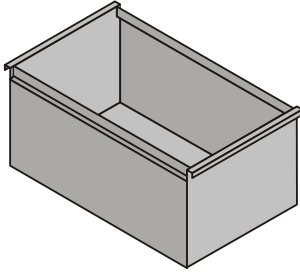

Hanging File Insert - Letter

SPECIFICATIONS:

- letter size
- edges of steel folded under for safe handling

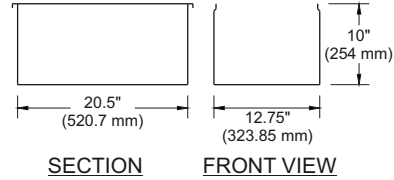

APPLICATION:

- storage of letter size files

- Security Equipment -



- Financial Institutions -

Product ID: Vault Cupboard Acc.

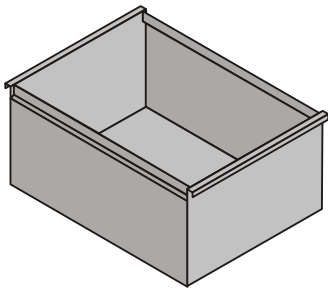

Hanging File Insert - Legal

SPECIFICATIONS:

- legal size
- edges of steel folded under for safe handling

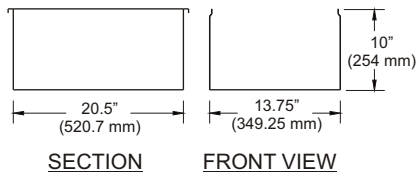

APPLICATION:

- storage of legal size files

Product ID: Vault Cupboard Acc.

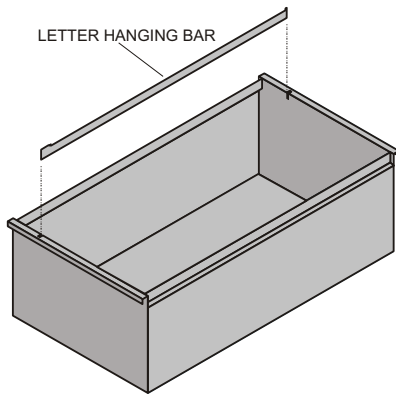

Hanging File Insert - Lateral

SPECIFICATIONS:

- letter and/or legal size
- edges of steel folded under for safe handling

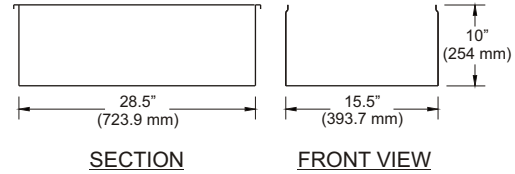

APPLICATION:

- lateral storage of letter and/or legal size files

- Security Equipment -



- Financial Institutions -

Product ID: Vault Cupboard Acc.

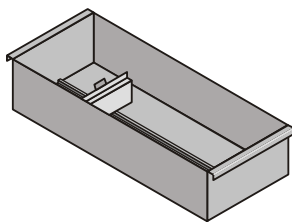

Small Index Card Tray

SPECIFICATIONS:

- comes with follower block to hold contents in place
- edges of steel folded under for safe handling

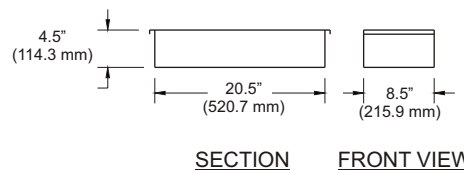

APPLICATION:

- storage of items such as cheques

Product ID: Vault Cupboard Acc.

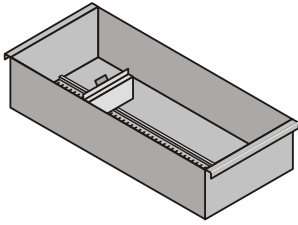

Medium Index Card Tray

SPECIFICATIONS:

- comes with follower block to hold contents in place
- edges of steel folded under for safe handling

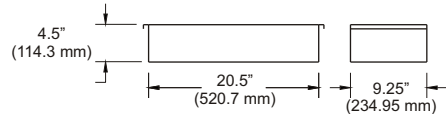

SECTION FRONT VIEW

APPLICATION:

- storage of items such as cheques

- Security Equipment -



- Financial Institutions -

Product ID: Vault Cupboard Acc.

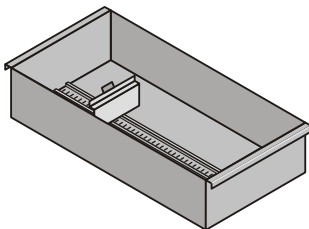

Large Index Card Tray

SPECIFICATIONS:

- comes with follower block to hold contents in place
- edges of steel folded under for safe handling

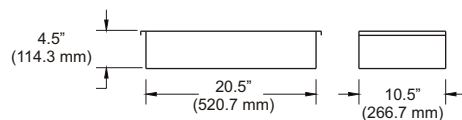

SECTION FRONT VIEW

APPLICATION:

- storage of items such as cheques

Product ID: Vault Cupboard Acc.

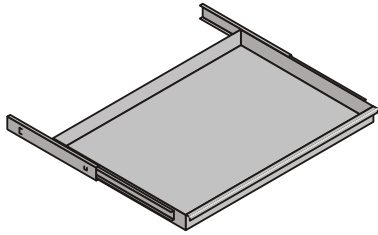

Main Pull-Out Tray

SPECIFICATIONS:

- pulls out easily on smooth ball bearing slides
- full extension slides are rated for up to 220 lbs
- edges of steel folded under for safe handling

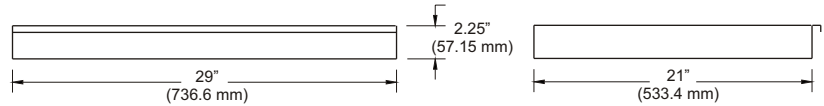

FRONT VIEW

SECTION

APPLICATION:

- easily access contents within a cabinet by rolling the tray out to its maximum extension

- Security Equipment -



- Financial Institutions -